

# VERTICAL BLIND FACE FIXING FITTING INSTRUCTIONS

## FITTING COMPONENTS

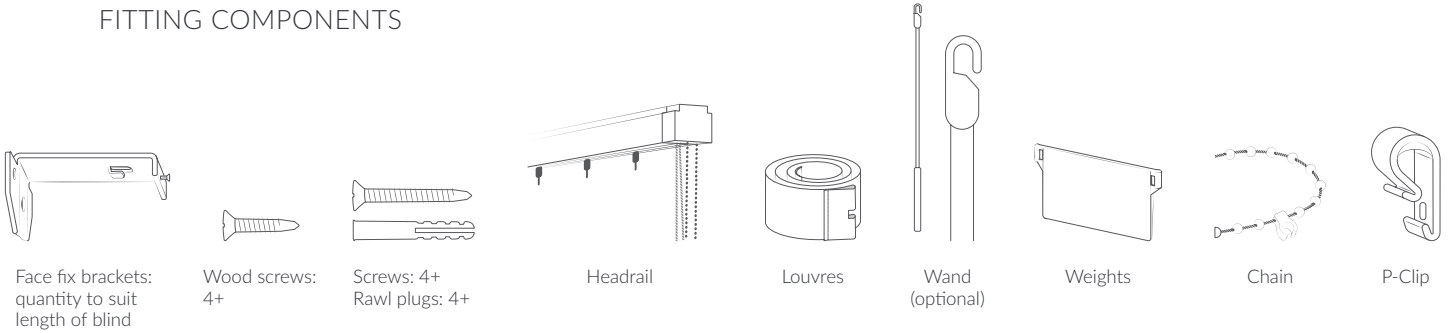

## FITTING HARDWARE



### 1 BRACKET POSITION

Place blind in fitting position, space the brackets evenly.

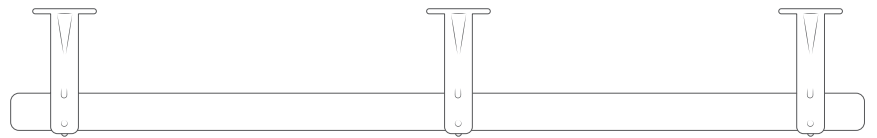

### 2 INSTALLING THE BRACKETS

#### Face Fixing

Position bracket against the surface and mark out the holes in the bracket. Use rawl plugs if fitting to the wall.

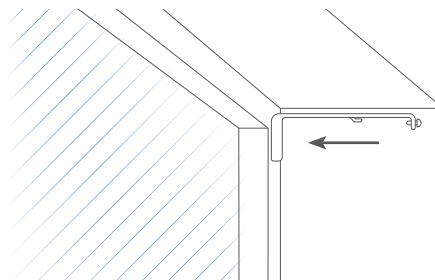

### 3 FITTING THE HEADRAIL

Remove packing material from track, releasing the cord and chain (cord control traverses louvres and chain control rotates them).

Clip the headrail onto the bracket by resting the rail onto position A, then bring the headrail towards you and tighten the screw.

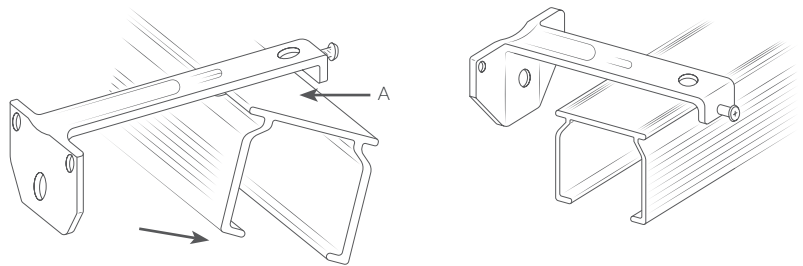

### 4 ADJUSTING THE HEADRAIL

Turn the hooks so that the slots are 90° to the track.



**IMPORTANT:**  
Do not close the blinds with louvres in closed position. Always turn them 90° to the track before operating cord control.

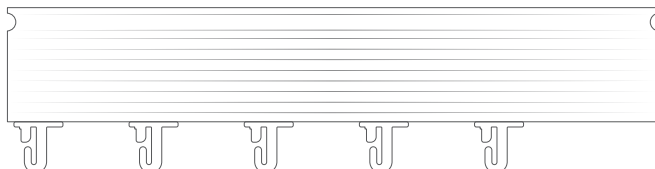

## 5 FITTING THE LOUVRES

Using the plastic hook in the top of the first louvre, place onto the headrail hook. Repeat for all louvres ensuring they are all facing the same direction.

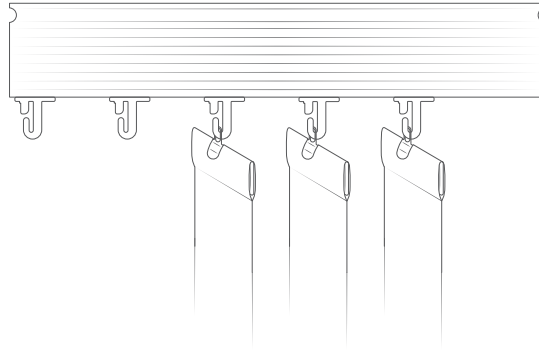

## 6 FITTING THE WEIGHTS

Simply slide the weights into the pocket at the bottom of the louvres, make sure the lugs are at the top near the seam line.

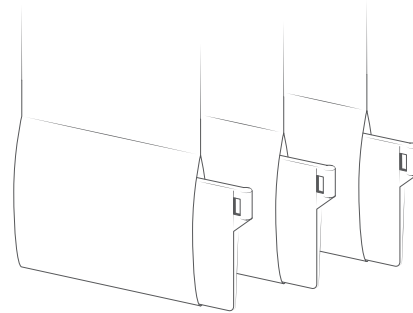

## 7 FITTING THE CHAIN

To attach the chain to the weights, simply slide the clip down the lug of the weight. Do not push the clip onto the lug, this will only weaken the clip or cause it to snap completely.

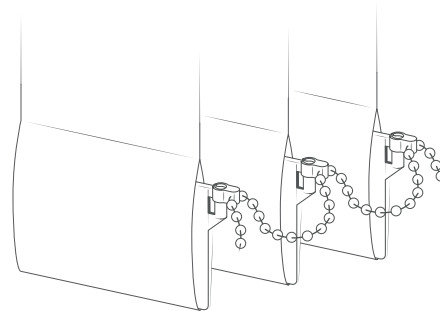

## 8 OPERATING YOUR BLIND

### Chain/Cord System

Use the operating chain at the side to gently rotate the louvres. Use the operating cord at the side to open and close the blind (only when the louvres are fully open).

### Wand System

Twist the wand to rotate the louvres. Pull the wand across in either direction to open and close the blind.

### P-Clip

The device must be installed at maximum distance possible from the control mechanism, and not less than 1.5m from the floor, to prevent the looped cord/chain from becoming slack.

1. Make sure the chain and cord are hanging loose where you want them to be secured.
2. Ensure the chain and cord are taut, the P-Clip is at the bottom of the loops and that the chain and cord are able to manoeuvre correctly.
3. Screw the P-Clip to a wall adjacent to the blind ensuring the chain & cord remain taut. The controls will be held permanently taut and under constant tension.

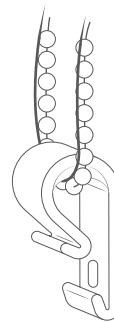

Assembly and installation of this product can be completed by non-professionals, in accordance with current trade and safety standards. Please consult a professional if any doubt exists.

Young children can be strangled by loops in pull cords, chains, tapes, and inner cords that operate the product. To avoid strangulation and entanglement, keep cords out of the reach of young children. Cords may become wrapped around a child's neck. Move beds, cots and furniture away from window covering cords. Do not tie cords together. Make sure cords do not twist and create a loop.